

Article number: 204150M16200D0T
 Description: E+G levelling foot
 GN 41-50-M16-200-D0-T
 Note: T Without nut, Wrench flat at the bottom

Measures

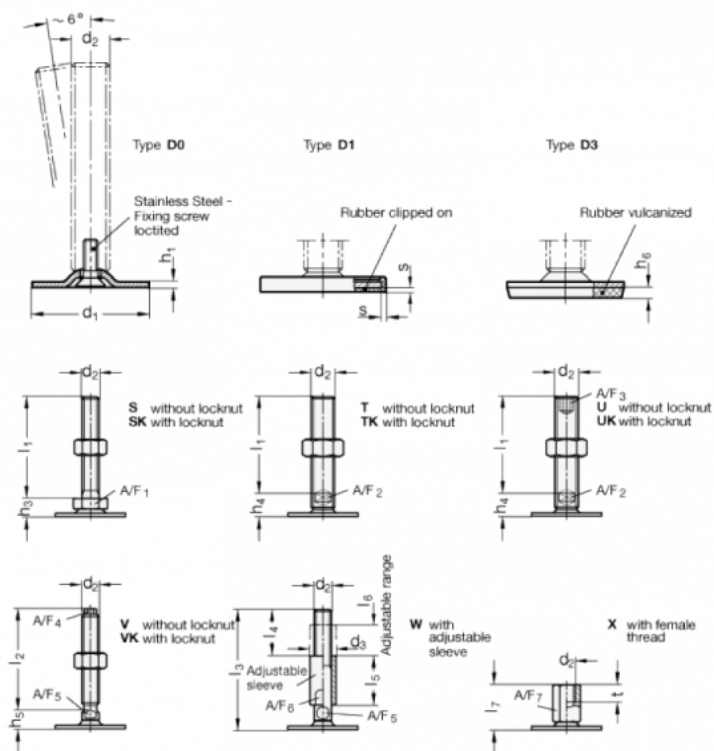

A/F2 = 12
 d1 = 50
 d2 = M16
 h1 = 2.5
 h4 = 17
 h6 =
 l1 = 200
 s =